



UNITED STEEL PRODUCTS

ROLLING STEEL SERVICE DOORS MODEL 300



36"0" x 16'0" Rolling Door @ Toys'r'Us in Whitestone, NY.

SPECIFICATIONS

Furnish Rolling Service Doors, series 300 as manufactured by "USP" complete with curtain, hood, guides, counterbalance and options as specified.

OPERATION

- manual lift
- chain hoist using gear reduction and galvanized hand chain
- internal or external industrial motors
- hand crank using gear reduction and removable hand crank

CURTAIN MODEL 300 consists of interlocking slats cold rolled formed from hot dipped galvanized steel with optional baked on grey polyester enamel coating or 304 stainless steel with a #4 finish curved profile (SC3) or flat profile (SF3). Each end of alternate slats are to be assembled with galvanized malleable cast iron end locks to maintain slat alignment and to act as a wearing surface inside the door guides. Slats are designed to withstand windloads of 20 psf. Windlocks are furnished for greater windloads and upon request(consult factory). Slat thickness shall be calculated with U.S. gauging with a minimum of 20ga. for doors up to 22' 4" wide and 18ga. for wider spans. Steel slats are to be hot dipped galvanized as per A.S.T.M. A653. Each curtain shall receive a bottom bar to maintain slat alignment and posture.

BOTTOM BAR shall consist of two steel factory painted angles a minimum 1/8" thick. Includes rubber astragal to form a weathertight seal upon closing service door.

SPRING COUNTERBALANCE is to be housed in a steel pipe of the appropriate diameter and wall thickness as to support curtain. Deflection shall be limited to a maximum of .03" per ft. of door width. Springs are to consist of helical torsion type designed to meet a 25% safety load factor. Safety factor allows for safe operation, ease of use, and longer spring life. Springs are to be grease packed and anchored, using a cast iron anchor, to a cold rolled steel inner shaft. Spring tension shall be fully adjustable from outside of end bracket plate. To insure smooth operation end bracket plates shall contain sealed ball bearings to minimize wear of pipe shaft.

HIGHLIGHTS

- **Heavy duty construction**
- **Torsion spring counterbalance**
- **Galvanized steel hood**
- **3" steel angle guides**
- **20 gauge galvanized steel curtain**
- **Malleable iron endlocks**
- **Double steel angle bottom bar**
- **Easy servicing**

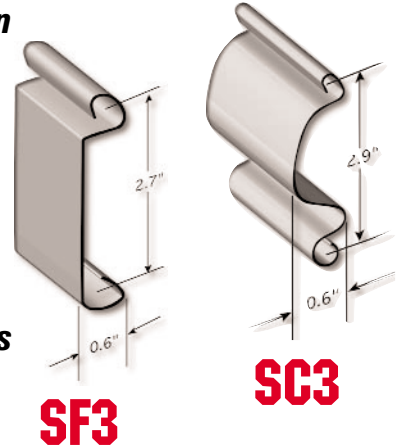

END BRACKET plates shall consist of factory painted steel plates no less than 3/16" thick. Bracket plates are to house pipe shaft and counterbalance assembly. Shaft is attached to plate by sealed ball bearings fitted onto plate.

GUIDES shall consist of factory painted structural steel angles a minimum of 3" wide and 3/16" thick. Guides will bolt together and feature a removable door stop. The guide depth shall be of a length adequate to provide for proper slat penetration and specified windloading. When windlocks are to be provided a windlock bar shall be furnished within guide to prevent curtain from leaving the guides under windload.

HOODS shall consist of a minimum of #24 gauge hot dipped galvanized steel with a baked on grey or bronze polyester enamel coating. Hoods are designed to protect and house counterbalance assembly. To prevent hood sag intermediate supports shall be furnished as required.

LOCKING for manual and chain operated doors to be slidebolts mounted on bottom bar with provisions for padlocks. Gearing within motors to be self locking.

FINISH all non-galvanized surfaces shall receive a factory coat of rust inhibiting enamel. Field painting not included in this section.

INSTALLATION to be by USP or by an authorized dealer.

OPTIONS

- Baked on grey polyester enamel slats •
- Poly-cote polyester powder coating, 200 select colors •
- Weatherseal package •
- High cycle springs • Sloping bottom bar • Pass door •
- 18 gauge steel slats • Stainless Steel Slats • Aluminum Slats •
- Grille section • Perforated slat section • Acrylic vision lites •
- Safety edge • Remote Control • Timer to close •
- Cylinder locks • Electric interlocks •
- Insulated slats (see Model 400) • Fire Door (see Model 700) •

C L E A R A N C E D E T A I L S 3 0 0 S E R I E S

MANUAL OPERATION

CHAIN OPERATION

MOTOR OPERATION

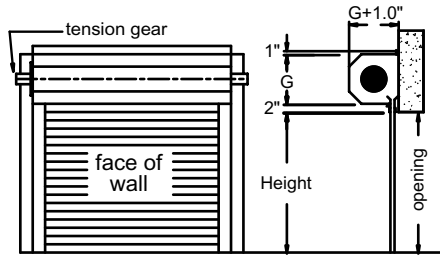

Models:
SC3-10
SF3-10

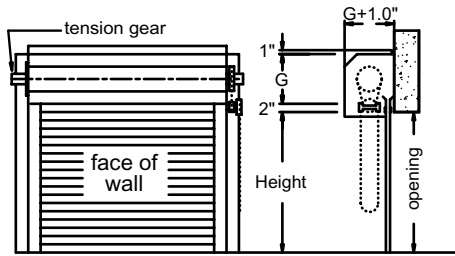

Models:
SC3-20
SF3-20

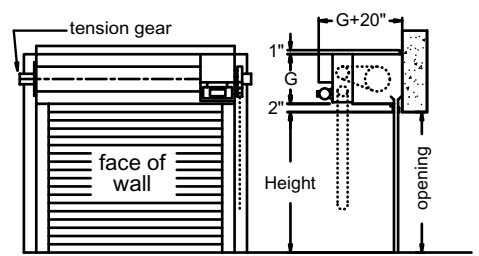

Models:
SC3-40
SF3-40

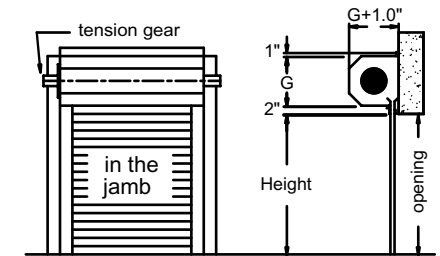

Models:
SC3-15
SF3-15

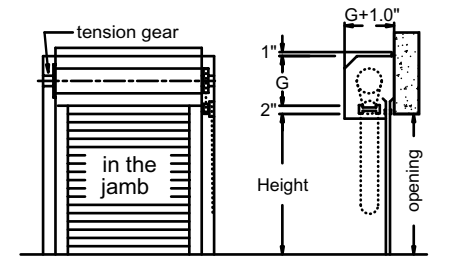

Models:
SC3-25
SF3-25

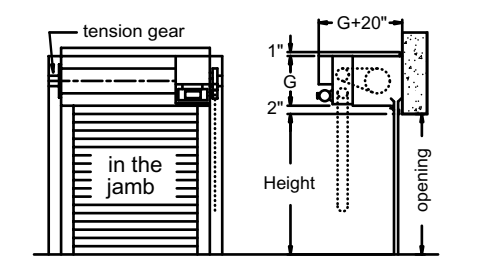

Models:
SC3-45
SF3-45

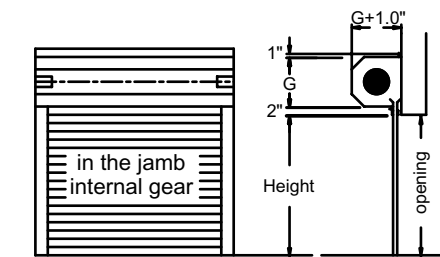

(up to 100 sq.ft.)
Models:
SC3-25TW
SF3-25TW

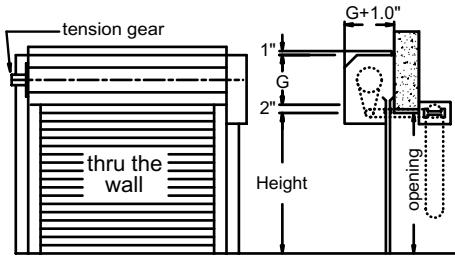

Models:
SC3-25TW
SF3-25TW

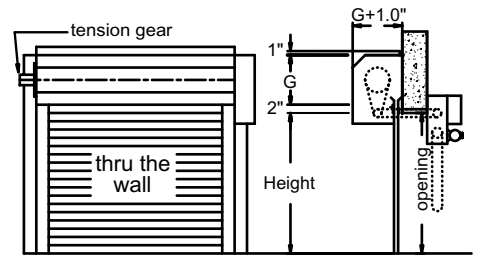

Models:
SC3-45TW
SF3-45TW

E-MOUNT

Z-MOUNT

BETWEEN THE JAMBS

BETWEEN THE JAMBS (CHAIN/MOTOR OPERATION)

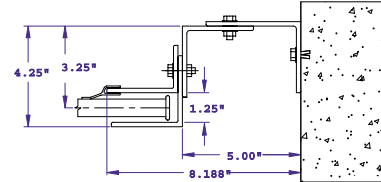
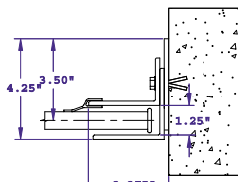
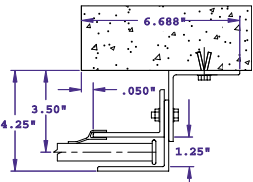
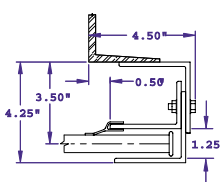

3" wide guide show with optional guide seals

For fastening to steel using machine bolts or welding

For fastening to masonry using expansion bolts or through the wall threaded rod (if required.) 4" guides on spans over 22'4" or with windlocks Where clearances are critical, dimensions may be reduced. Refer inquiries to our Engineering Department.

CURTAIN FINISH

- GS** Galvanized steel
- PS** Polyester enamel over galvanized
- SS** Stainless steel

STANDARD LOCKING



HEIGHT	G	G windlocks
up to 6'6"	15"	16"
6'6" up to 10'0"	16"	17"
10'0" up to 12'0"	17"	18"
12'0" up to 14'6"	18"	19"
14'6" up to 17'0"	19"	20"
17'0" up to 19'0"	20"	21"
19'0" up to 21'0"	21"	22"
21'0" up to 23'0"	22"	23"

WIDTH	A	B	C	D
to 22'4"	6.75"	9.25"	8.25"	3.375"
22'4" to 28'4"	7.75"	10.75"	9.25"	N/A
over 28'4"	consult factory			

United Steel Products, Inc.
33-40 127th Place Flushing, New York 11368
(718) 478-5330
<http://www.unitedsteelproducts.com>